

<b>NORLEG</b>	
Hytteby enkelt m. rutschebane	
C10052-G	
16.11.2017	REV. -

< 1000

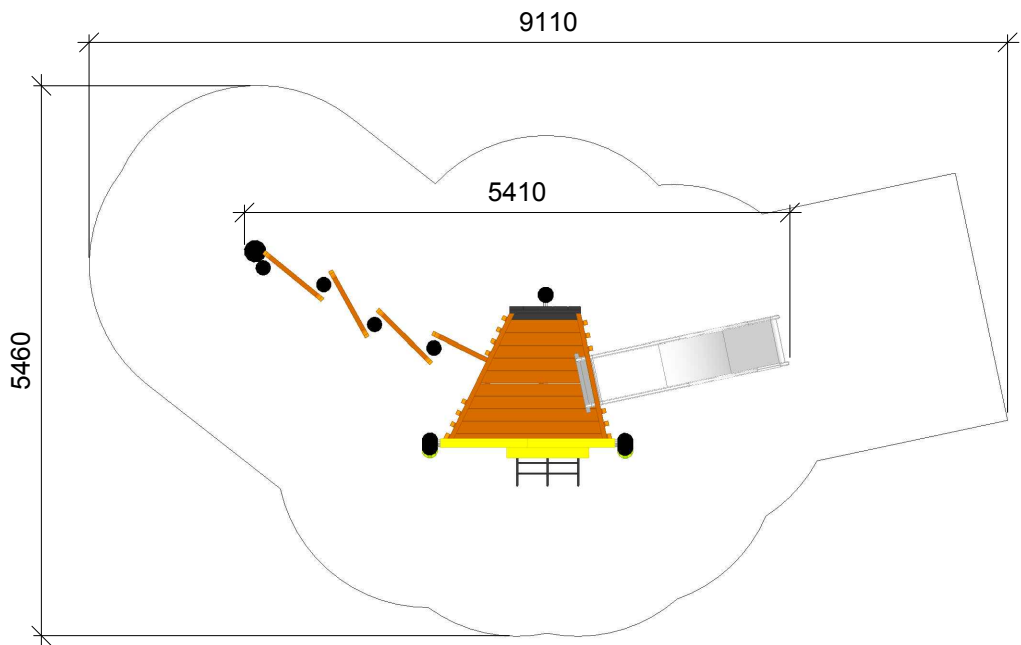

≥ EN 1176

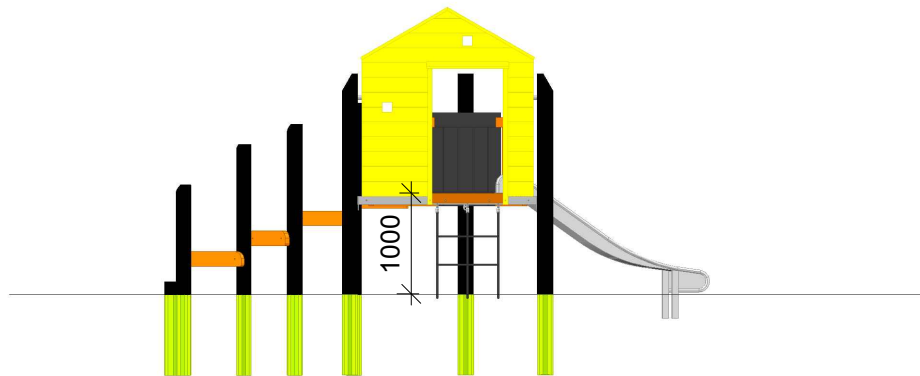
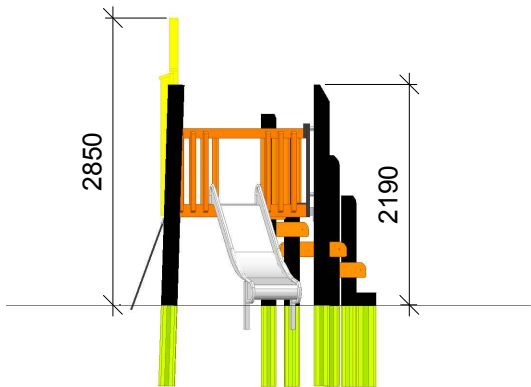

This drawing is the property of NORLEG and pursuant to current legislation may not be copied, transferred to or used by any third party. Should this drawing be used, a fee of 10% of the assumed contract price will be charged.

1:75

<b>NORLEG</b>	
Hytteby enkelt m. rutschebane	
C10052-G	
16.11.2017	REV. -

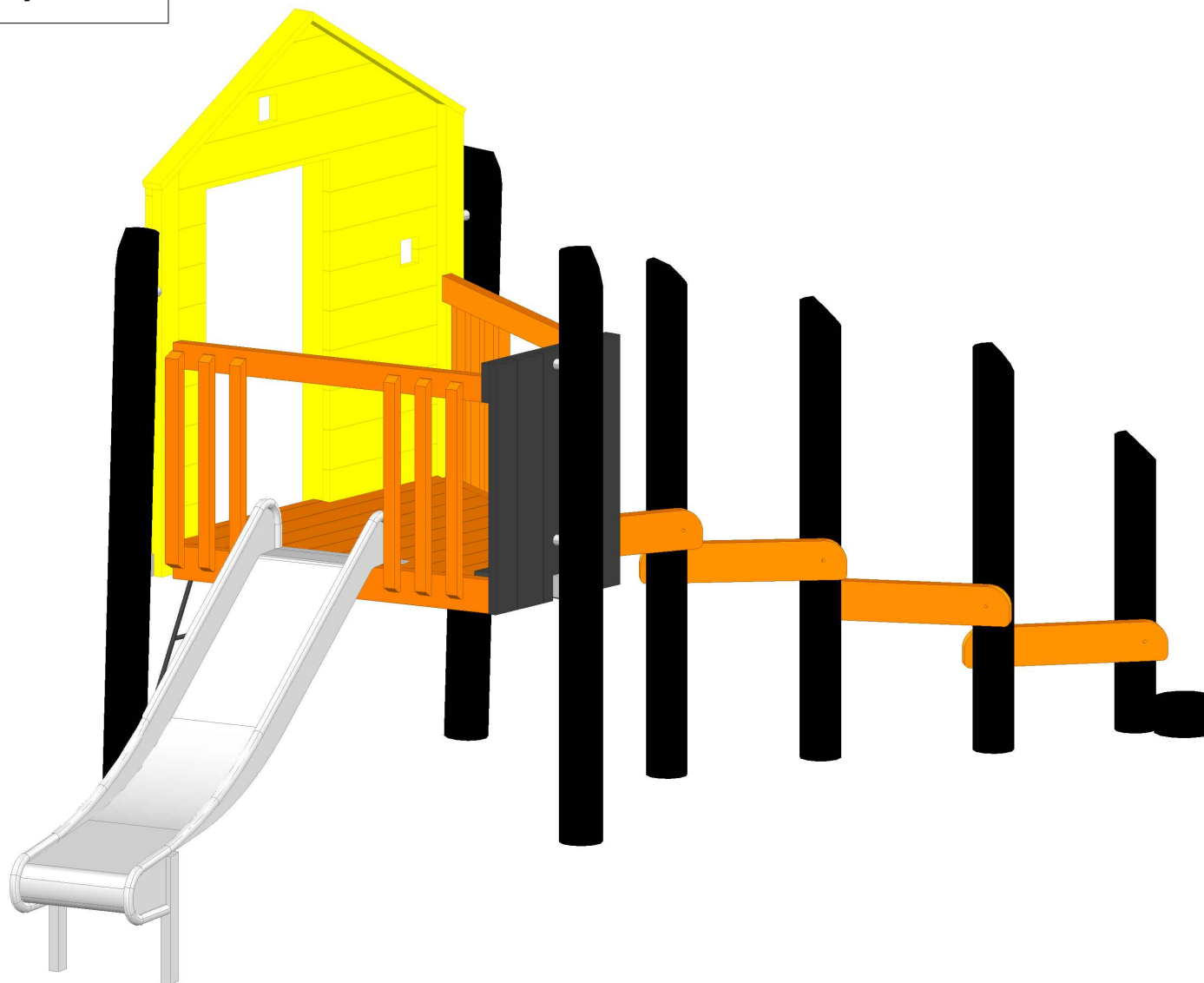

This drawing is the property of NORLEG and pursuant to current legislation may not be copied, transferred to or used by any third party. Should this drawing be used, a fee of 10% of the assumed contract price will be charged.

<b>NORLEG</b>	
Hytteby enkelt m. rutschebane	
C10052-G	
16.11.2017	REV. -

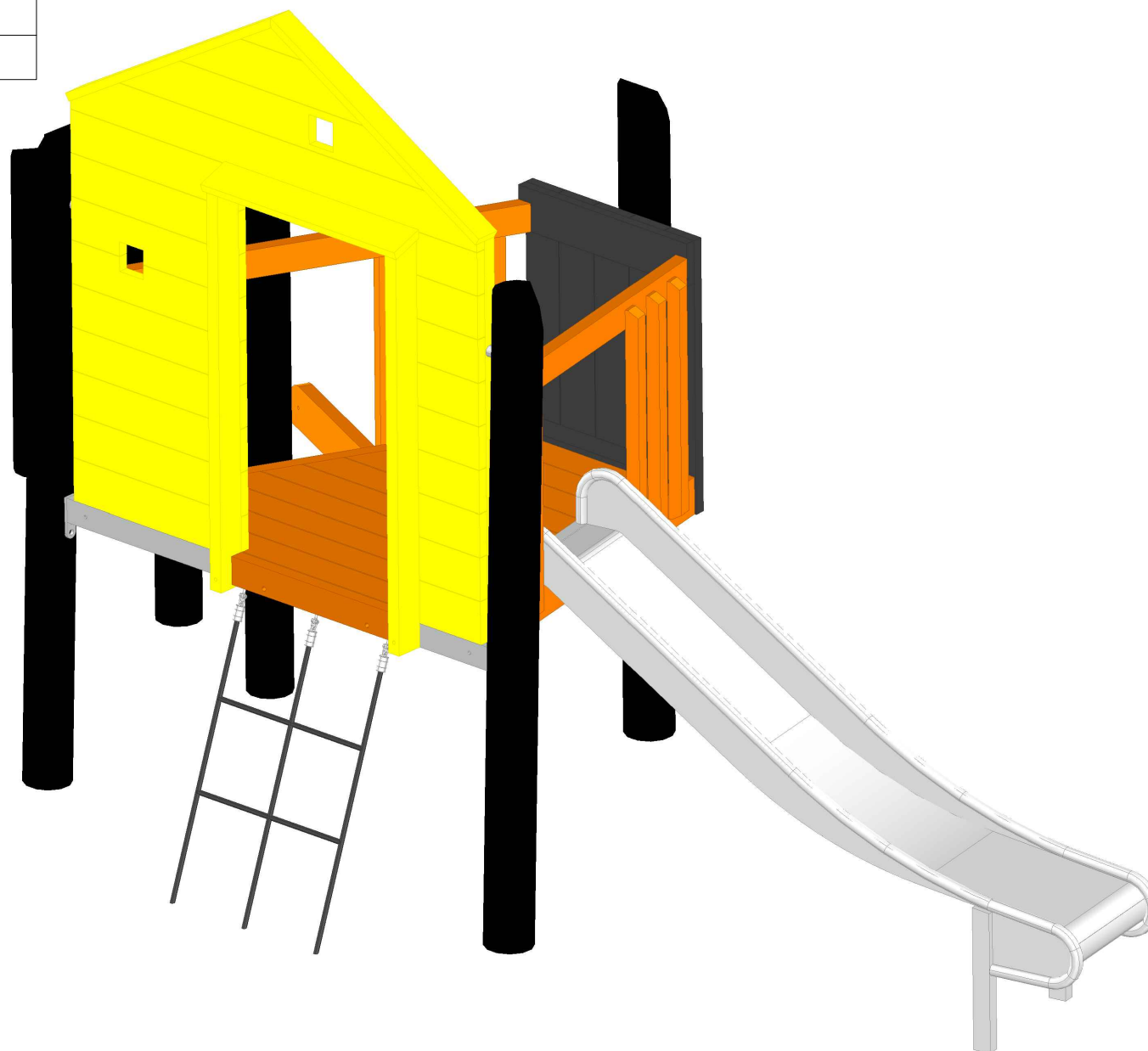

This drawing is the property of NORLEG and pursuant to current legislation may not be copied, transferred to or used by any third party. Should this drawing be used, a fee of 10% of the assumed contract price will be charged.

<b>NORLEG</b>	
Hytteby enkelt m. rutschebane	
C10052-G	
16.11.2017	REV. -

< 1000



≥ EN 1176



1900

1700

1930

<b>NORLEG</b>	
Hytteby enkelt m. rutschebane	
C10052-G	
16.11.2017	REV. -

< 1000

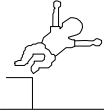

≥ EN 1176

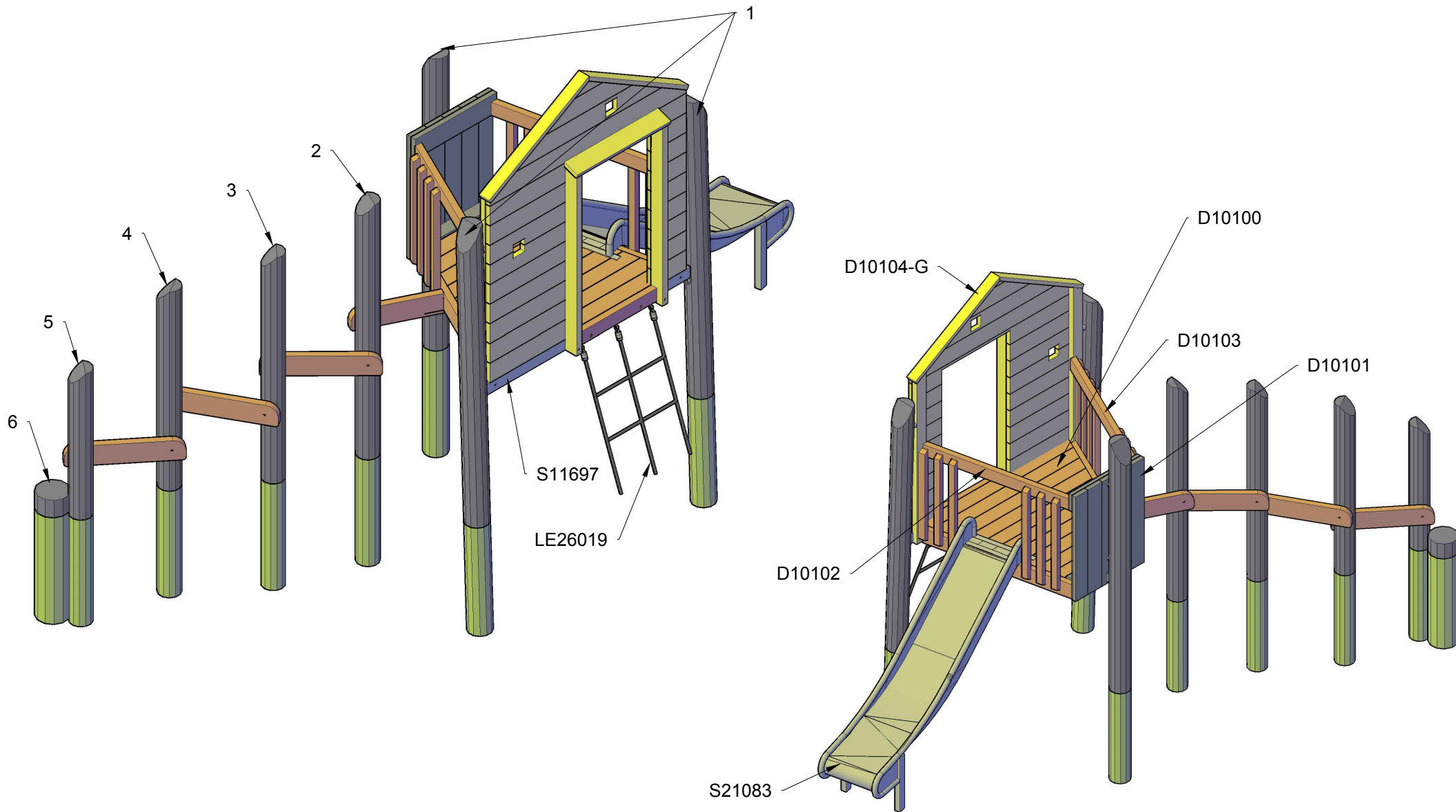

This drawing is the property of NORLEG and pursuant to current legislation may not be copied, transferred to or used by any third party. Should this drawing be used, a fee of 10% of the assumed contract price will be charged.

# NORLEG

Hytteby enkelt m. rutschebane

C10052-G

16.11.2017

REV. -

< 1000

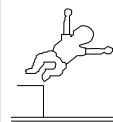

≥ EN 1176

Mont.p. nr.

19  
34  
54A  
72

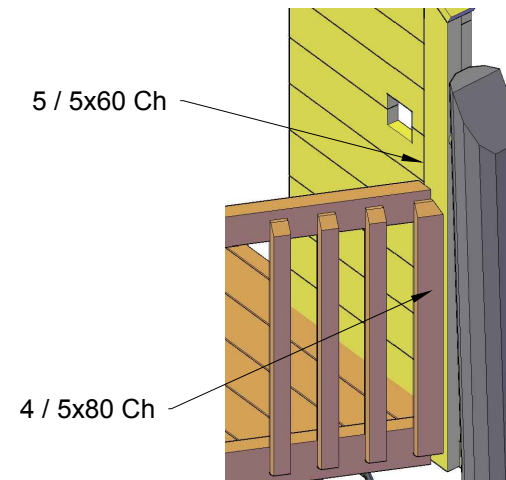
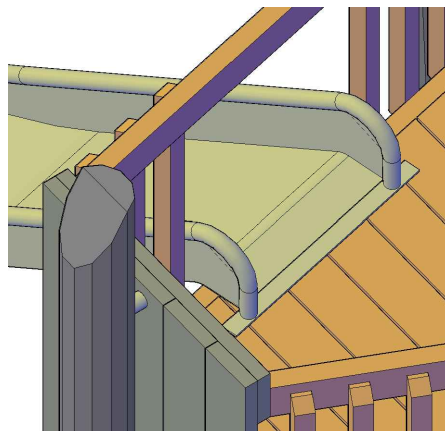

- Mont.

